



**CATÁLOGO 2025**

**[www.birk.com.br](http://www.birk.com.br)**





**A Birk uma empresa fundada em 1996, na cidade de Boituva, sempre especializada em plásticos de injeção.**

**São quase 30 anos buscando desenvolver inovação e qualidade e através de produtos que atendam às necessidades do mercado e as normas vigentes.**

**Somos uma empresa que somente consome e gera energia limpa, contribuindo de forma positiva ao meio ambiente, com isso contribuimos com a redução de mais de 600 toneladas de Co<sup>2</sup> no meio ambiente.**

# PARA-LAMA

Modelo RDN  
após 2008 injetado

Código Birk: BKRN-5001  
Para-lama modelo RDN  
injetado após 2008

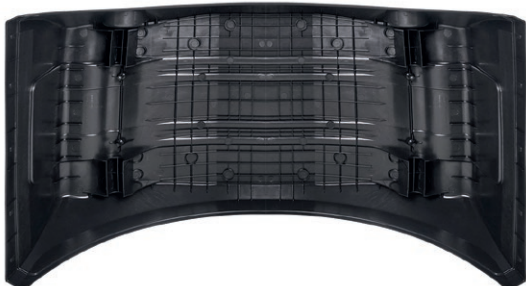

Injetado, espessura e nervuras  
Uniformes para maior resistência



Encaixe do suporte não aparente,  
evitando acúmulo de sujeira

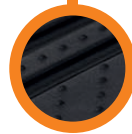

Superfície com textura  
Anti derrapante

Tamanho:

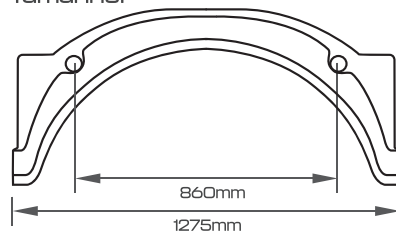

665x1275x500mm

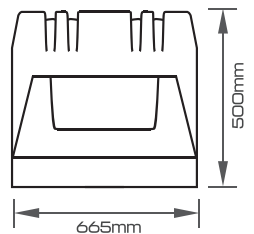

# PARA-LAMA

Modelo RDN  
até 2007 injetado

Código Birk: BKR-3001  
Para-lama modelo RDN  
injetado até 2007



Nervuras por toda a peça possibilitando  
Maior rigidez em toda extensão

Leve e resistente



Guias do suporte não aparentes  
Evitando o acúmulo de sujeira

Superfície com textura  
Anti derrapante

Tamanho:

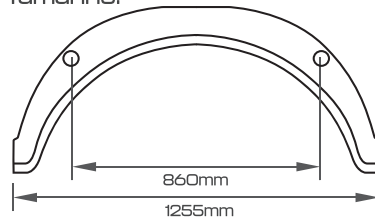

650x1255x500mm

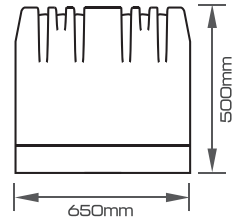

# PARA-LAMA

Modelo FCH  
até 2011 injetado

Código Birk: BKR-1001  
Para-lama modelo FCH  
injetado até 2011



Injetado, possibilitando uma espessura  
Uniforme e um material mais resistente

Nervuras por toda a peça, possibilitando  
Maior rigidez em toda extensão



Leve e resistente

Tamanho:

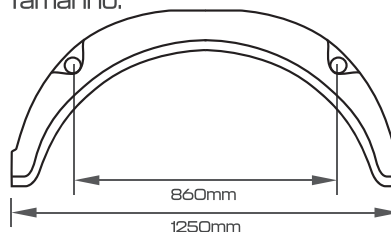

660x1250x500mm

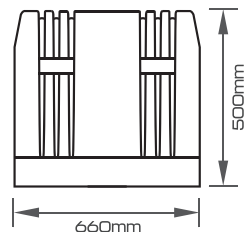

# PARA-LAMA

Modelo RDN após 2008  
injetado prolongado

Código Birk: BKRNP-001  
Para-lama modelo RDN injetado  
prolongado após 2008

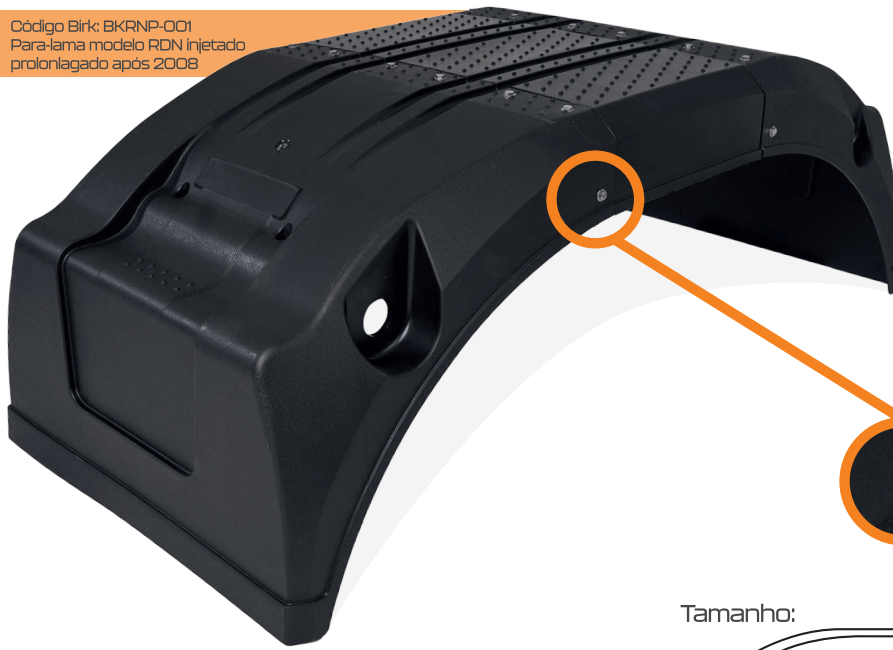

Elementos de fixação em inox

Tamanho:

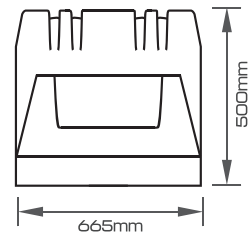
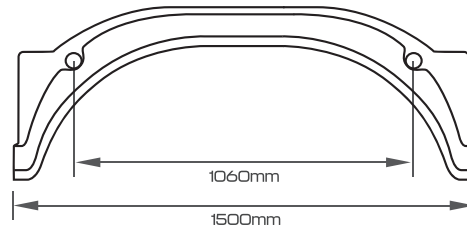

665x1500x500mm

Código Birk: BKP-02  
Prolongador para-lama  
modelo RDN após 2008



# PARA-LAMA

Modelo RDN até 2007  
injetado prolongado

Código Birk: BK-57  
Para-lama modelo RDN injetado  
prolongado até 2007

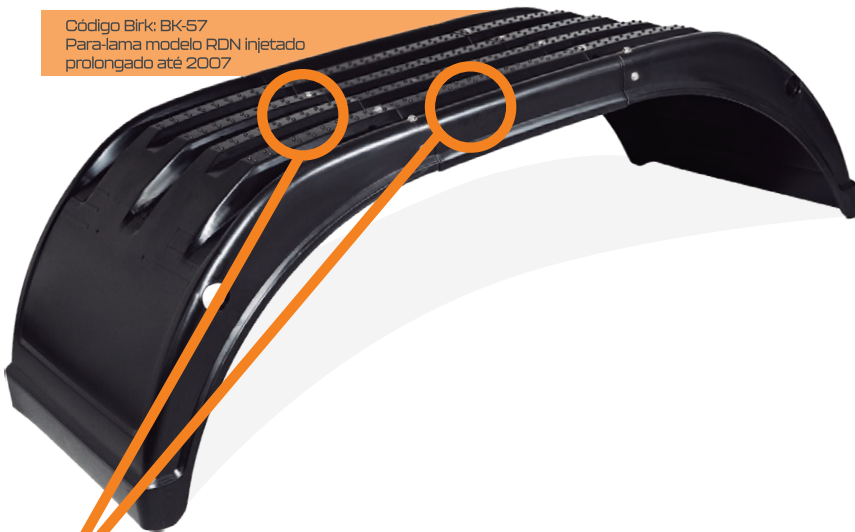

Código Birk: BK-54  
Prolongador Para-lama  
modelo RDN até 2007



Melhora no tempo de produção  
Evitando retrabalho interno

Tamanho:

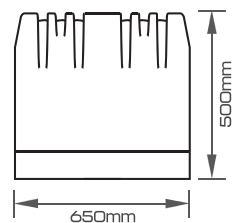
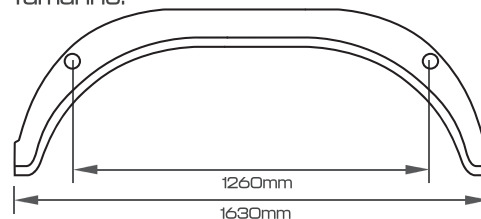

650x1630x500mm

Elementos de fixação em aço-inox

Para-lama e prolongador injetados

# PARA-LAMA

## Modelo envolvente caminhões 3/4

Código Birk: BK-04  
Para-lama envolvente injetado  
caminhões 3/4



Produto injetado, espessura uniforme  
Por toda a peça

Fácil fixação por suportes ou na  
Parte superior

Design robusto, conferindo  
Maior durabilidade



Material de engenharia especialmente  
Desenvolvido para a aplicação

Tamanho:

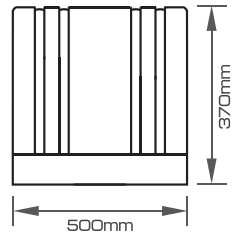
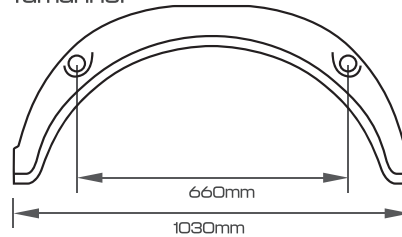

500x1030x370mm

# PARA-LAMA

## Modelo envolvente rodagem simples - VUC

Código Birk: BK-08  
Para-lama envolvente  
Rodagem simples - vuc



Aplicação para veículos  
Urbanos de carga

Forte e resistente



Tamanho:

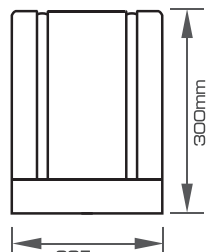
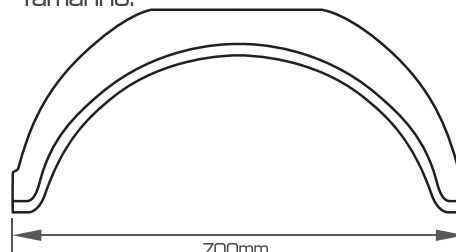

305x700x300mm

# PARA-LAMA

Modelo single

Código Birk: BK-16  
Para-lama single



Estrutura especialmente desenvolvida  
Com tecnologia de ponta



Forte e resistente

Tamanho:

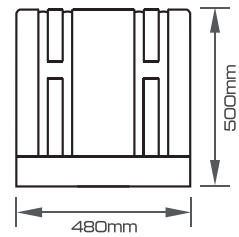
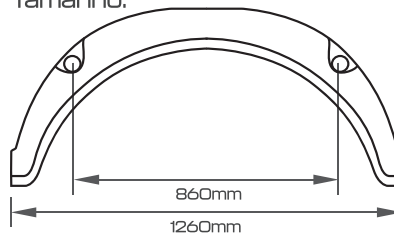

480x1260x500mm

# PARA-LAMA

Modelo Volvo FH

Código Birk: FH-002  
Para-lama tração volvo  
Fh mod. 2015 - parte central



Código Birk: FH-001  
Para-lama tração volvo  
Fh mod. 2015 - parte dianteira



Código Birk: FH-007  
Protetor interno do  
Meio Para-lama volvo fh



Código Birk: FH-004  
Para-lama tração volvo  
Fh mod. 2015 - parte traseira

Código Birk: FH-003  
Tampa lateral Para-lama  
Tração - volvo fh - dianteiro



Código Birk: FH-005  
Tampa lateral Para-lama  
Tração - volvo fh - traseiro

# PARA-LAMA

Modelo MB Axor/  
Actros

Código Birk: AX-001  
Para-lama tração mb axor  
Parte superior - central



Código Birk: AX-002  
Para loma tração mb axor  
Parte traseira - sem tampa



Código Birk: AX-004  
Para-lama tração mb axor  
Parte diant. L.D.



Código Birk: AX-003  
Para-lama tração mb axor  
Parte dianteira I.E.

Código Birk: AX-005  
Tampa da parte traseira do  
Para-lama tração mb axor



Código Birk: AX-006  
Presilhas de borracha Para-lama  
Mb axor



# PARA-LAMA

Modelo florestal

Código Birk: BKF-001  
Para-lama florestal  
1200x700x5mm



Código Birk: BKF-002  
Para-lama florestal  
1200x550x5mm

Forte e resistente

Espessura de 5mm

Customizável com sua logo marca

Fazemos tamanhos diversos - consulte

Tamanhos:

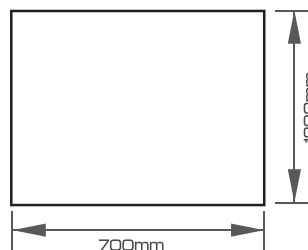

700x1200mm

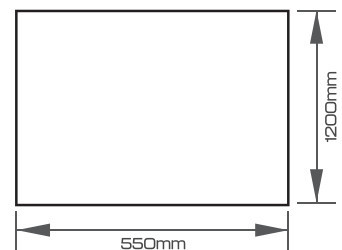

550x1200mm

# PARA-LAMA

Modelo Scania  
tri-partido

Código Birk: SC-001  
Para-lama scania tri-partido  
Parte central



Código Birk: SC-003  
Meio Para-lama tri-partido  
Dianteiro direito/traseiro esquerdo



Código Birk: SC-002  
Meio Para-lama tri-partido  
Dianteiro esquerdo/traseiro direito



Código Birk: SC-004  
Presilhas de borracha do  
Para-lama scania tri-partido



# MEIO PARA-LAMA

Modelo RDN após 2008  
injetado com aba

Código Birk: BKRN-5214  
Meio para-lama modelo RDN após  
2008 injetado com aba - direito



Código Birk: BKRN-5314  
Meio para-lama modelo RDN após  
2008 injetado com aba - esquerdo

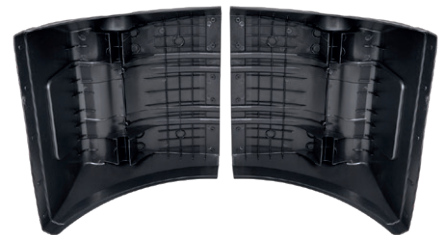

Com aba para fixação

Guias do suporte não aparentes,  
evitando o acúmulo de sujeira

Tamanho:

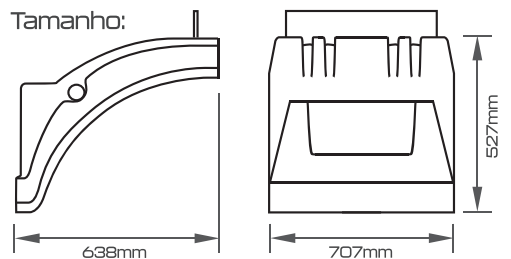

707x638x527mm

# MEIO PARA-LAMA

Modelo RDN  
após 2008 injetado



Código Birk: BKRN-5215  
Meio Para-lama birk 2023  
Sem abas - direito

Código Birk: BKRN-5315  
Meio Para-lama birk 2023  
Sem abas - esquerdo



Superfície anti derrapante

Guias do suporte não aparentes,  
evitando o acúmulo de sujeira

Tamanho:

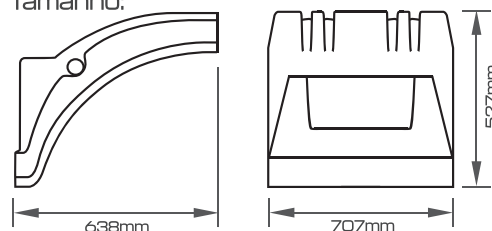

707x638x527mm

# MEIO PARA-LAMA

Modelo FCH  
até 2011 injetado



Código Birk: BK-1301  
Meio para-lama modelo FCH até 2011  
Traseiro esquerdo/ dianteiro direito

Código Birk: BK-1201  
Meio para-lama modelo FCH até 2011  
Traseiro direito/ dianteiro esquerdo

Com aba para fixação

Fornecido também sem  
Furação - cod -BK-1200



Tamanho:

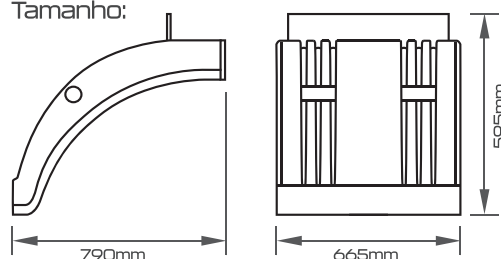

665x790x595mm

# MEIO PARA-LAMA

Modelo RDN  
até 2007 injetado

Código Birk: BKR-3303  
Meio para-lama modelo RDN até 2007  
Traseiro esquerdo/ dianteiro direito

Código Birk: BKR-3304  
Meio para-lama modelo RDN até 2007  
Traseiro direito/ dianteiro esquerdo

Superfície anti derrapante

Guias do suporte não aparentes  
Evitando o acúmulo de sujeira



Tamanho:

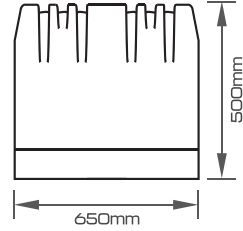
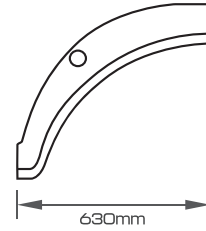

650x630x500mm

# MEIO PARA-LAMA

Modelo  
caminhões 3/4

Código Birk: BK-1550  
Meio para-lama injetado caminhões 3/4  
Traseiro esquerdo/ dianteiro direito

Código Birk: BK-1551  
Meio para-lama injetado caminhões 3/4  
Traseiro direito/ dianteiro esquerdo

Submetido a testes de impacto e  
vibração

Customizável com sua  
Logo marca

Fácil instalação, possibilitando  
Redução de tempo e custos

Tamanho:

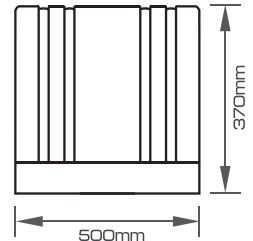
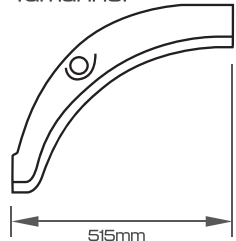

500x515x370mm

# MEIO PARA-LAMA

VUC



Customizável com sua Logo marca

Injetado resistente, leve e robusto

Fácil instalação

Código Birk: BK-07  
Descrição: meio-Para-lama vuc

Tamanho:

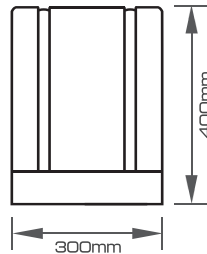
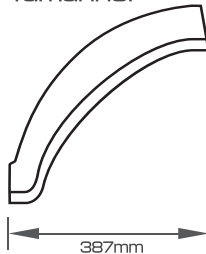

300x387x400mm

# CAIXA

Ferramentas 130 Litros

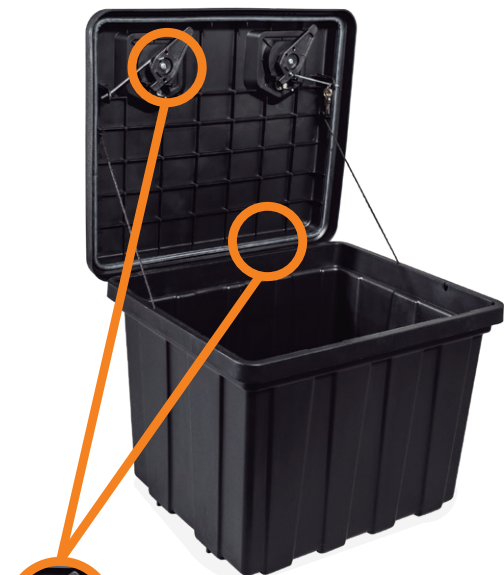

Código Birk: BKC-003  
Caixa de ferramentas 130 litros

Fechamento triplo

Fechaduras externas com chaves

Totalmente vedada

Customizável com sua logo marca

Tamanho:

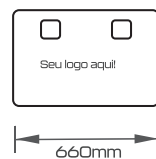
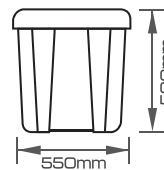
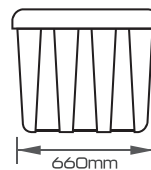

660x550x500mm

# CAIXAS

Ferramentas 40 E 50 litros



Código Birk: BKC-002  
Caixa de ferramentas  
50 litros



Código Birk: BKC-001  
Caixa de ferramentas  
40 litros

Customizável com sua logo marca



Fechamento triplo



Fechaduras externas com chaves



Totalmente vedada

Tamanhos:

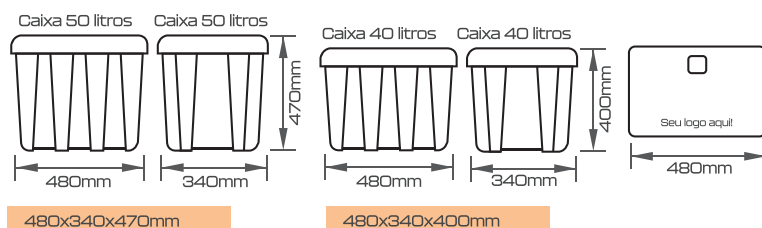

# PARA-BARROS

Anti-spray

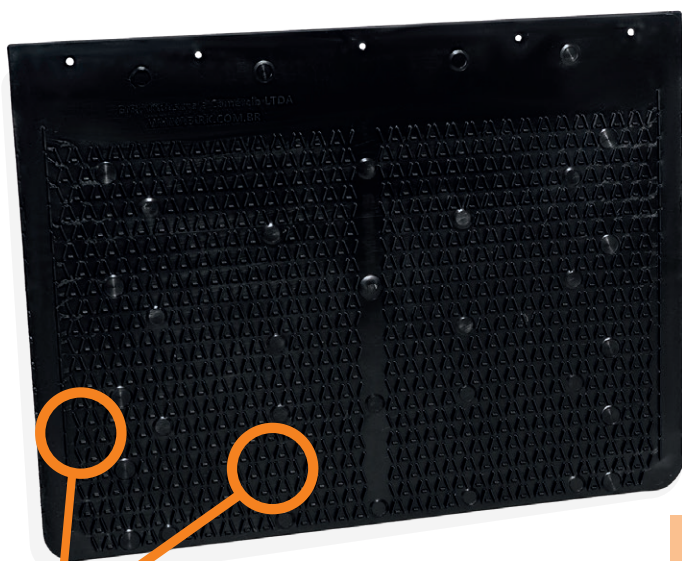

Código Birk: PBAS-001  
Parabarro anti-spray 500x600



Código Birk: PBAS-003  
Parabarro anti-spray 500x630



Código Birk: PBAS-002  
Parabarro anti-spray 520x680

O anti-spray é um item de segurança que evita acidentes e se tornará obrigatório a partir de janeiro de 2023, segundo a resolução nº 888, de 13 de dezembro de 2021 do contran.

Tamanhos:

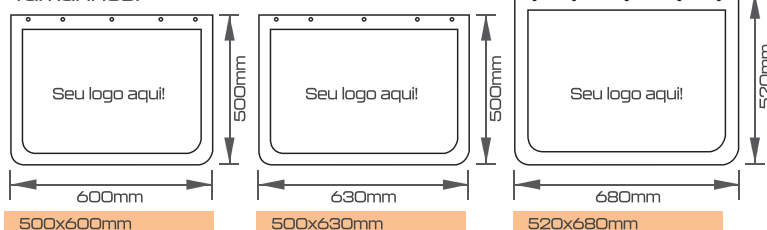

Dissipadores desenvolvidos para Gerar o máximo de eficiência

Calhas laterais para o escoamento da água

# PARA-BARROS

Luminescentes  
personalizados



**BIRK**  
Implementos Rodoviários

Para barro com pintura luminescente  
Desenvolvida pela birk.

Brilha no escuro

Maior visibilidade da sua marca

Disponível em qualquer medida de parabarro, convencional e anti spray



# PARA-BARROS

Luminescentes  
Nossa Senhora



Disponível em qualquer medida de parabarro,  
convencional e anti spray

Para barro com pintura luminescente  
Desenvolvida pela birk.

Brilha no escuro

Maior visibilidade da sua marca



# PARA-BARROS

Luminescentes  
face de Cristo



Disponível em qualquer medida de parabarro,  
convencional e anti spray

Para barro com pintura luminescente  
Desenvolvida pela birk.

Brilha no escuro

Maior visibilidade da sua marca

# PARA-BARROS

Multi-estampas



Código Birk: PB5028  
Liso sem relevo - 520x680



Código Birk: PB5029  
Liso sem relevo - 520x680



Código Birk: PB5030  
Liso sem relevo - 520x680



Código Birk: PB5031  
Liso sem relevo - 520x680

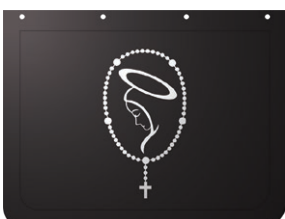

Código Birk: PB5032  
Liso sem relevo - 520x680

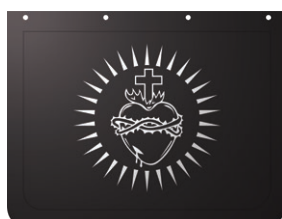

Código Birk: PB5033  
Liso sem relevo - 520x680



Código Birk: PB5025  
Liso sem relevo - 520x680



Código Birk: PB5027  
Liso sem relevo - 520x680

# PARA-BARROS

## Bandeiras



Código Birk: PB5012  
Liso sem relevo - 510x670



Código Birk: PB5013  
Liso sem relevo - 510x670



Código Birk: PB5014  
Liso sem relevo - 510x670



Código Birk: PB5015  
Liso sem relevo - 510x670



Código Birk: PB5016  
Liso sem relevo - 510x670



Código Birk: PB5017  
Liso sem relevo - 510x670



Código Birk: PB5018  
Liso sem relevo - 510x670



Código Birk: PB5019  
Liso sem relevo - 510x670



Código Birk: PB5020  
Liso sem relevo - 510x670



Código Birk: PB5021  
Liso sem relevo - 510x670



Código Birk: PB5022  
Liso sem relevo - 510x670



Código Birk: PB5023  
Liso sem relevo - 510x670

# PARA-BARROS

## Multi-marcas



**VOLKSWAGEN**

Código Birk: PB2154  
Liso sem relevo 500x600



**Mercedes-Benz**

Código Birk: PB2096  
Liso sem relevo 400x500



**VOLVO**

Código Birk: PB2156  
Liso sem relevo 400x500



**SCANIA**

Código Birk: PB2132  
Liso sem relevo 400x500



**FACCHINI**

Código Birk: PB1406  
Nervurado sem relevo 780x600



**NOMA**

Código Birk: fo- 2102  
Nervurado sem relevo 500x690



**FACCHINI**

Código Birk: PB1407  
Nervurado sem relevo 500x600



**NOMA**

Código Birk: fo2103  
Nervurado sem relevo 370x660

# PARA-BARROS

Personalizados

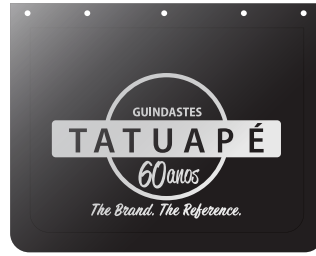

# PARA-BARROS

Lisos

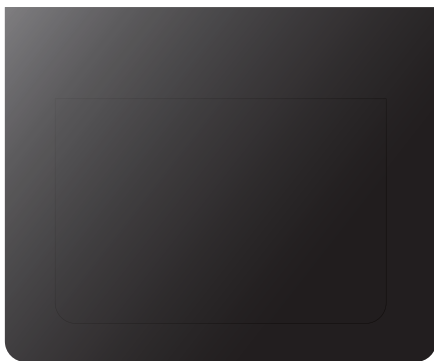

Código Birk: PB2621  
Liso sem relevo 600x730

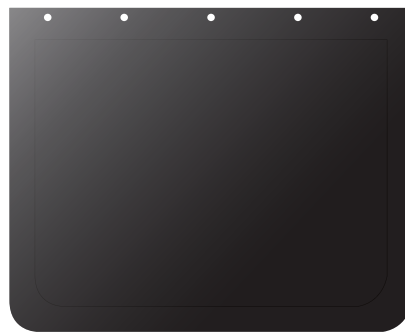

Código Birk: PB2227  
Liso sem relevo 520x680



Código Birk: PB4052  
Liso sem relevo 500x630



Código Birk: PB2223  
Liso sem relevo 800x480



Código Birk: PB2225  
Liso sem relevo 500x600



Código Birk: PB2224  
Liso sem relevo 500x500



Código Birk: PB6016  
Liso sem relevo 300x300

# PARA-BARROS

Nervurados

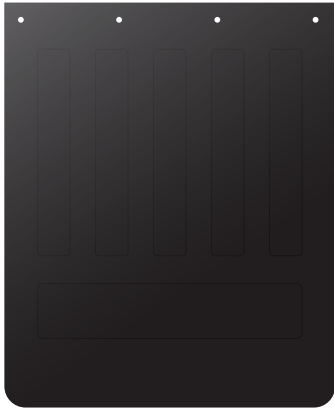

Código Birk: PB1017  
Nervurado sem relevo 780x600

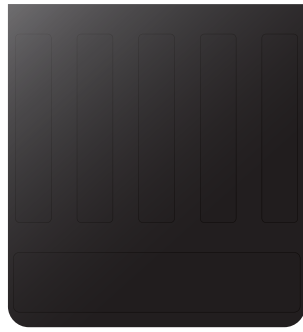

Código Birk: fc-1404  
Nervurado sem relevo 600x500

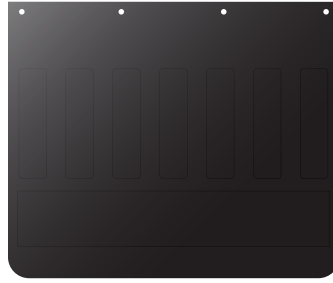

Código Birk: PB3065  
Nervurado sem relevo 500x600



Código Birk: PB4027  
Nervurado sem relevo 400x500

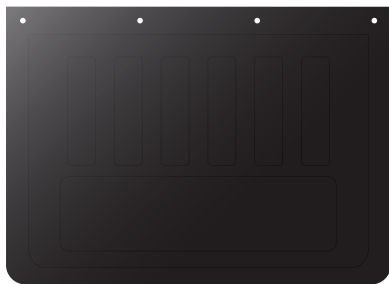

Código Birk: PB2102  
Nervurado sem relevo 500x690

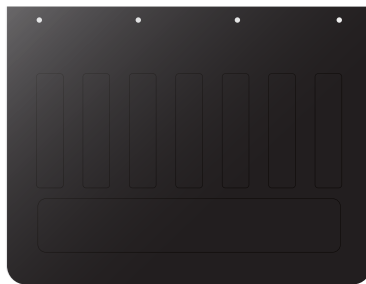

Código Birk: PB3068  
Nervurado sem relevo 500x680

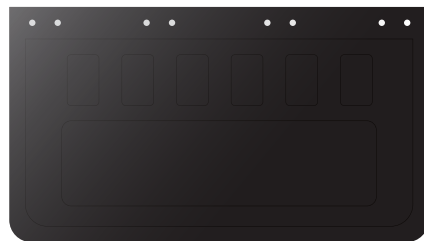

Código Birk: PB2103  
Nervurado sem relevo 370x660

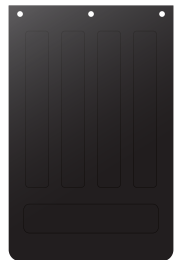

Código Birk: PB5001  
Nervurado sem relevo 450x290

# SUPORTE

Para-lama  
base universal



Código Birk: BK-23  
Suporte base universal 42x750mm  
sela 80mm

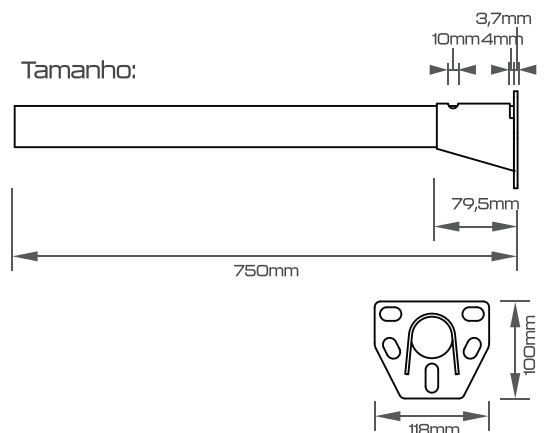

# SUPORTE

Para-lama  
base 3 furos

Código Birk: BK-60  
Suporte base três furos 42x750mm  
sela 80mm



# SUPORTE

Para-lama 3/4  
com parafuso

Código Birk: BK-81  
Suporte tubular 3/4 diam.25x650mm  
com parafuso para fixação

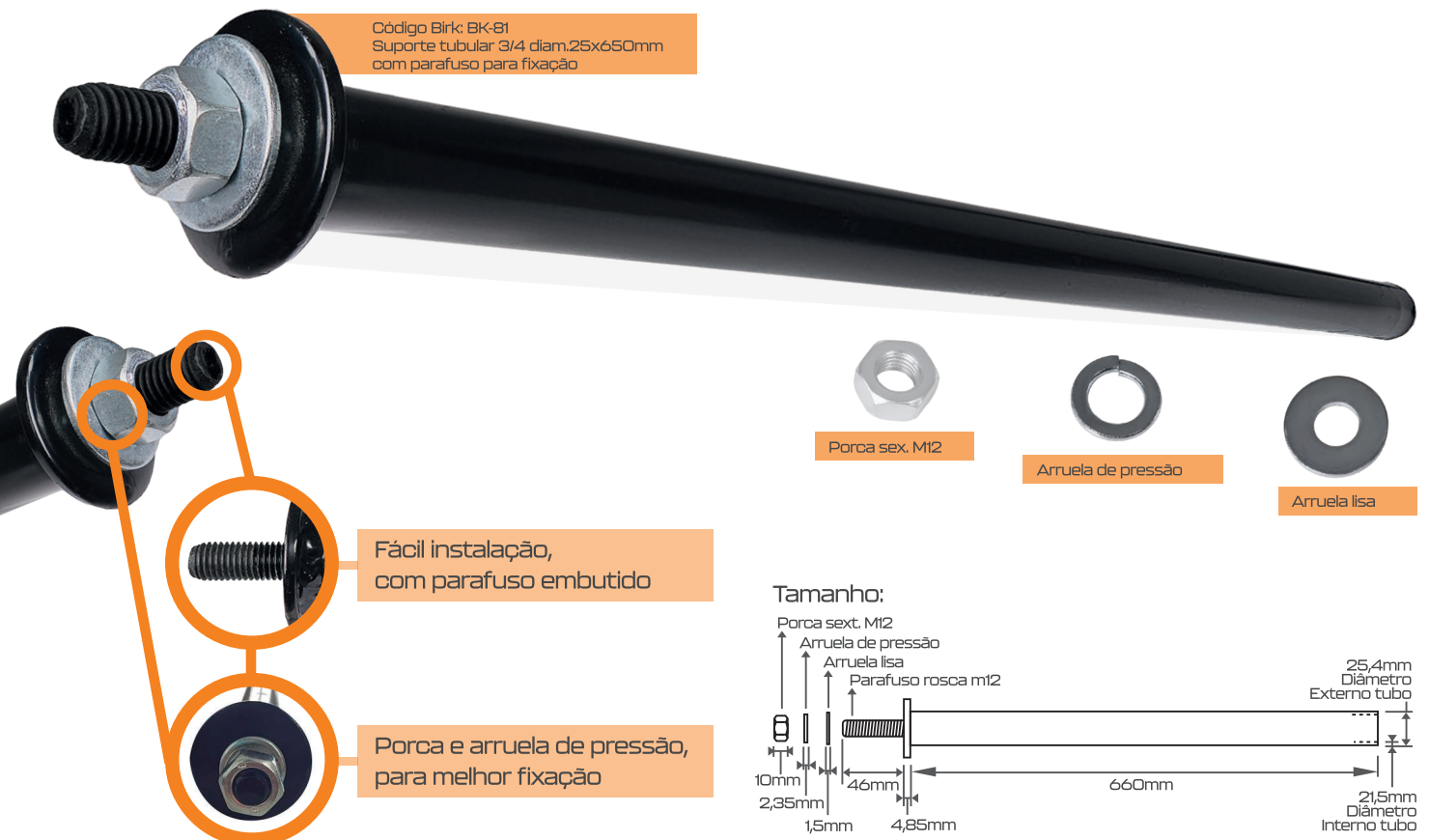

# SUPORTE

Para-lama 3/4

Código Birk: BK-24  
Suporte para lama 3/4 - 25x650mm

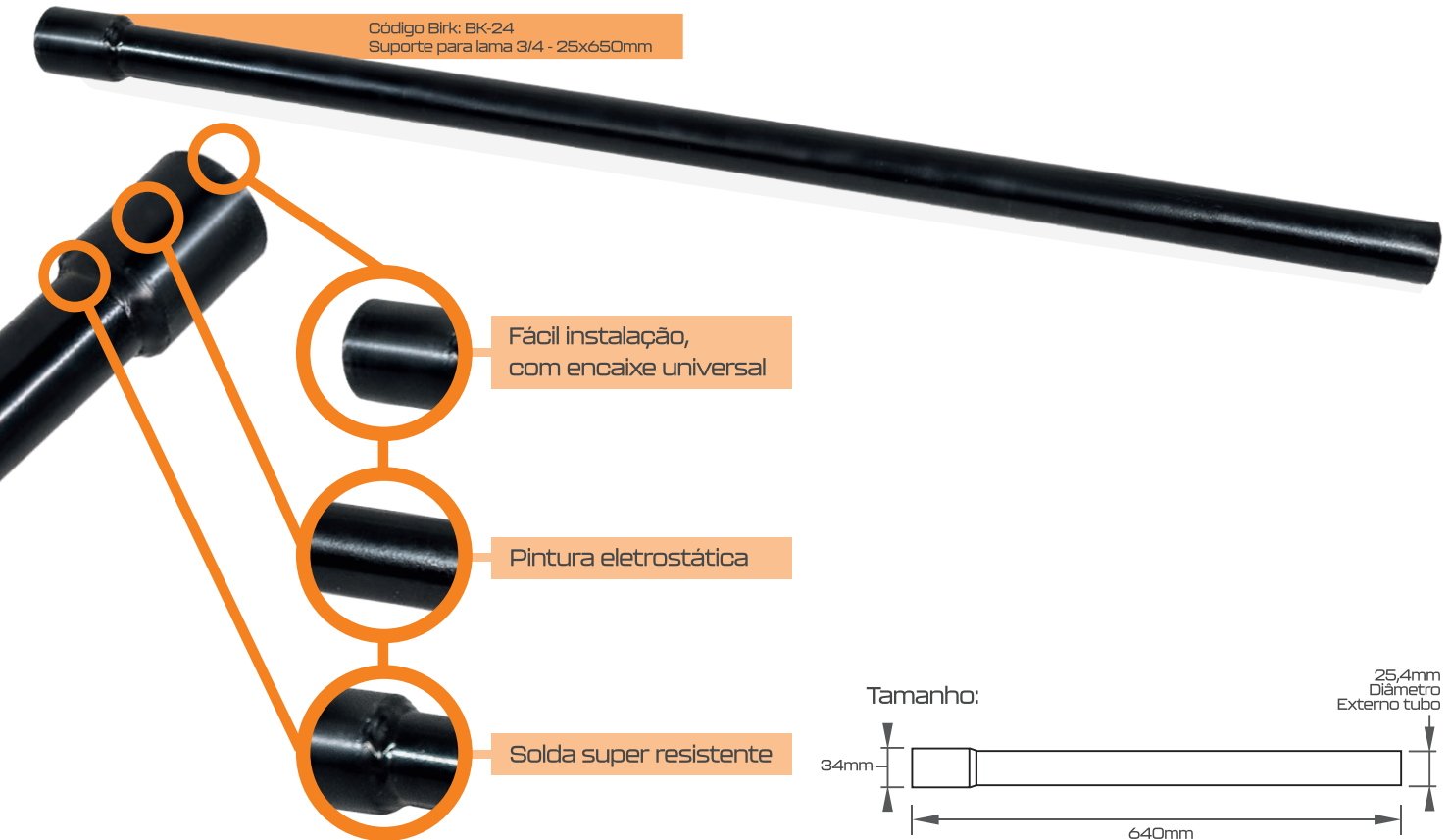

Fácil instalação,  
com encaixe universal

Pintura eletrostática

Solda super resistente

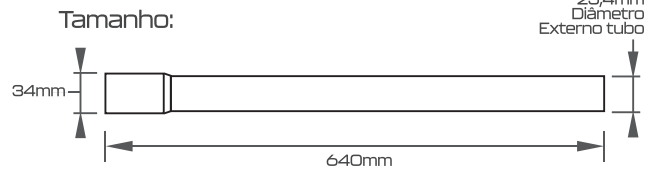

# SUPORTE

Caixa de ferramenta  
130 litros

Código Birk: BK-50  
Kit suporte caixa 130L

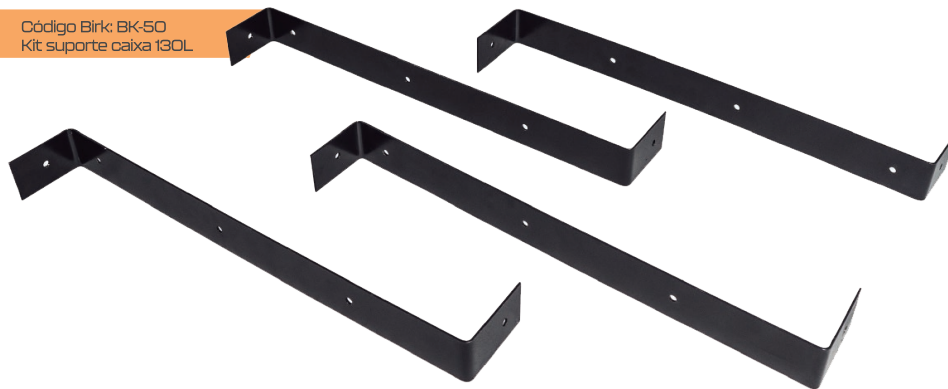

Com furos para fixação

Pintura eletrostática

Super resistente

Fácil instalação

Código Birk: BKP-007  
Conjunto caixa 130L c/ suporte



# SUPORTE

Caixas de ferramentas  
40 E 50 litros

Código Birk: BK-49  
Kit suporte caixa 40L e 50L



Com furos para fixação

Pintura eletrostática

Super resistente

Fácil instalação

Código Birk: BKP-005/ BKP-006  
conjunto caixa 40/50 l c/ suporte



# CALÇO DE RODAS

Injetado

Código Birk: CAL-002  
Calço pneu/roda NBR9735  
Para roda de caminhão

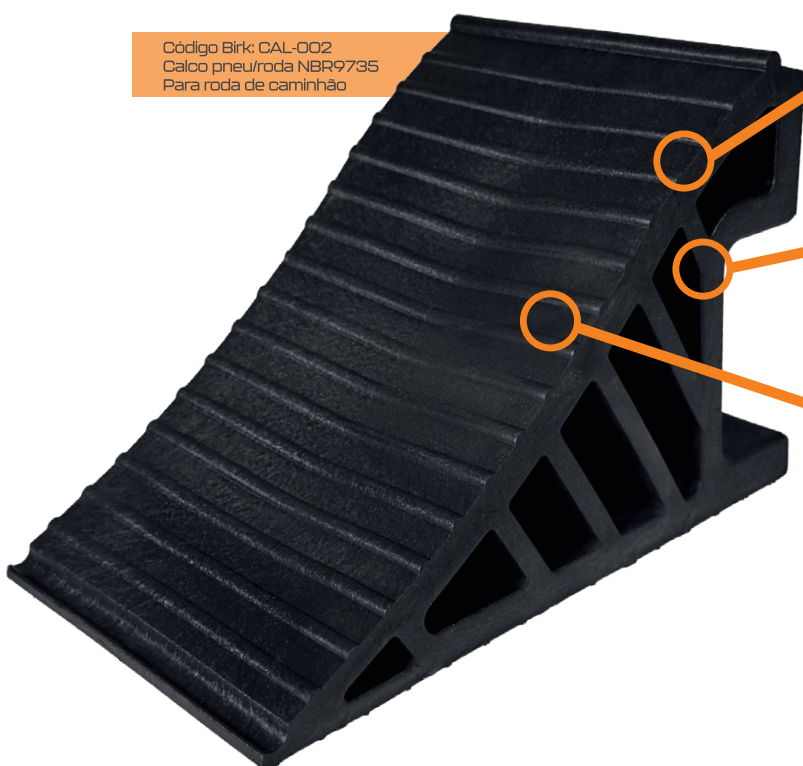

Com estruturas para maior  
Resistência, suportando  
20 toneladas por eixo

Encaixe para as mãos, com  
Melhor manuseio

Com nervuras, para melhor  
Ancoragem

Tamanho:

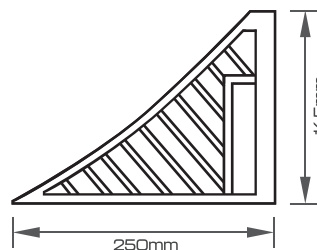
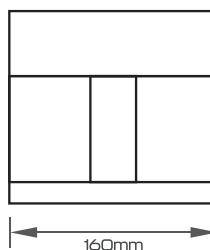

Aprovado na NBR 9735

215x160x165mm



**Fábrica:**

**Estrada Munic. Laércio Marson, Nº 490 - Boituva - SP**

**(11) 2905-0794 / 2905-0799**